

Good beds, heat stress and other stress factors in stables.

好牛床!如何減少牛舍的壓力來源



Strategies for cooling 散熱策略

Soaking and supplemental airflow 浸泡及空氣流動

- Can reduce 可減少:
 - Respiration rate 呼吸率 by 65-81 %
 - Body temperature 體溫降低 by 46-59 %

- Recommended approach 建議方法:
 - Soak skin with 1 liter of water within 1-1,5 min
用一公升的水浸泡皮膚大約1至1.5分鐘

 - Dry for 4 min 乾燥4分鐘

 - Repeat 重複相同步驟



Consequences with heatstress with dry cows

乾乳牛產生熱壓力的後果

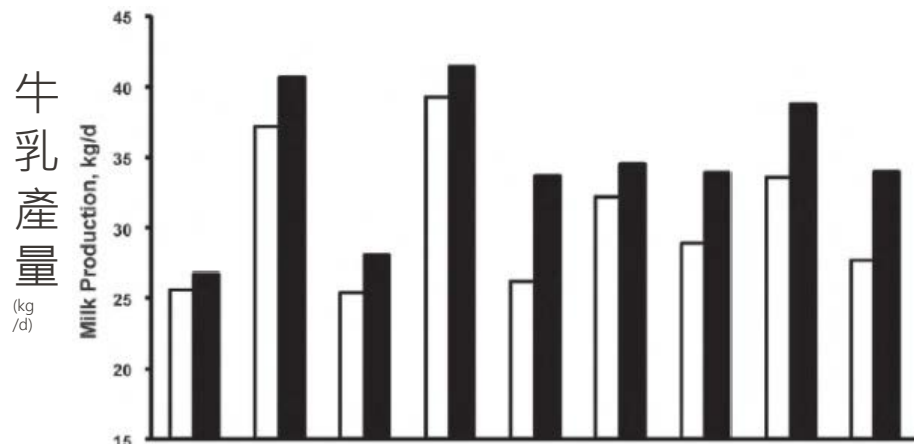

Black is dry cows without heatstress.
黑色代表沒有熱壓力的乾乳牛

White is dry cow there have heatstress when they was dry COWS.
白色代表有熱壓力的乾乳牛

Good beds are important 好的牛床的重要性

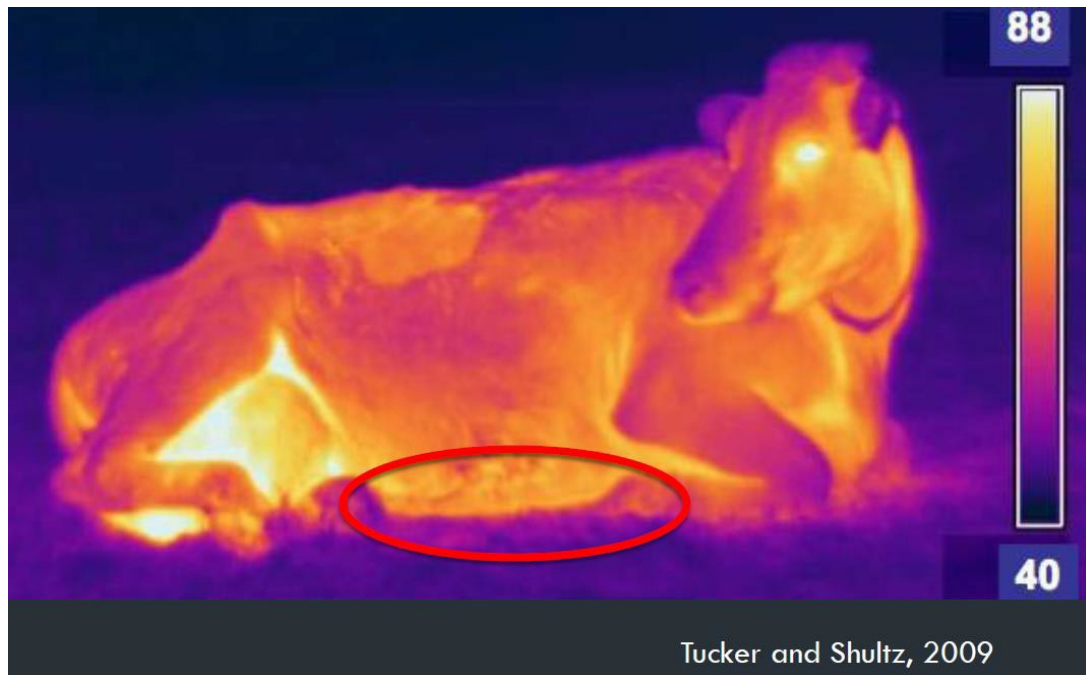

when cows lie down they make more milk.

當牛趴下時，能夠產出更多牛乳

they cool more off when lying down

藉由趴下，他們能夠散熱

Clean water and good cow traffic 乾淨飲水及好的牛隻動線

Drinking water 飲水

- Cows under influence of heat stress may consume up to 50 % more water
熱壓力的牛可能會多消耗50%以上的水
- At 30 C they need 150 Liters a day. The water requirement increases by 3 liter for every degree the temperature rises above 20 C

攝氏三十度時他們需要 150升/天 的水。溫度升高到20攝氏度以上時，每度需水增加3升。

Cow traffic牛隻動線

- Ranking order. 排序
- Loose cow 自由活動式乳牛

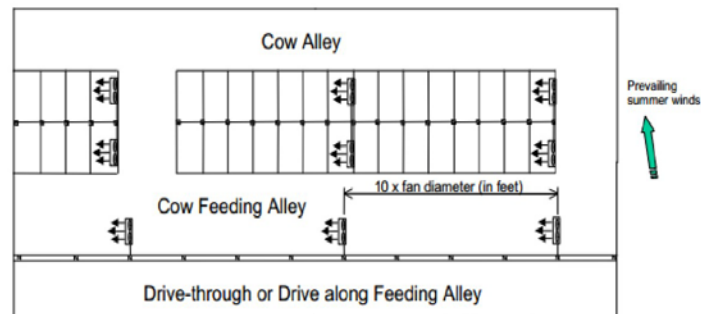

Heat strees 熱壓力

The cows would not lie down 牛隻不肯趴下

Bad cow traffic 不佳的牛隻動線

Not enough water 飲水不足

Losing milk and sick cows.

損失牛乳
及牛隻生病



SKIOLD GROUP

**INNOVATIVE SOLUTIONS
WITHIN FARM & FEED TECHNOLOGY**

SKIOLD INTRODUCTION

SKIOLD IS FULL-LINE SUPPLIER IN ALL BUSINESS AREAS:

SKIOLD 為以下領域的全場設備供應商：



SEED
PROCESSING
種子加工

Seed and
grain
processing
solutions



GRAIN
HANDLING
穀物處理

Professional
grain handling
solutions



FEED MILLING
PLANTS 飼料研磨

Feed milling
solutions for small
farms to large
industrial plants



EQUIPMENT FOR
POULTRY 家禽設備

Full-line
equipment for
broilers, layers,
rearing and
breeders



FULL-LINE
PIG FARMS
豬場全設備

Pig farms from
simple
components to
complete full-
line farms



HOUSING FOR
CATTLE FARMS
牛舍

Housing, climate
and feeding
solutions for
cattle farms



AQUA FEED
FARMS
水產飼料

High quality
aquatic feed
production to
meet your
specific needs

LIVESTOCK PRODUCTION 畜牧生產

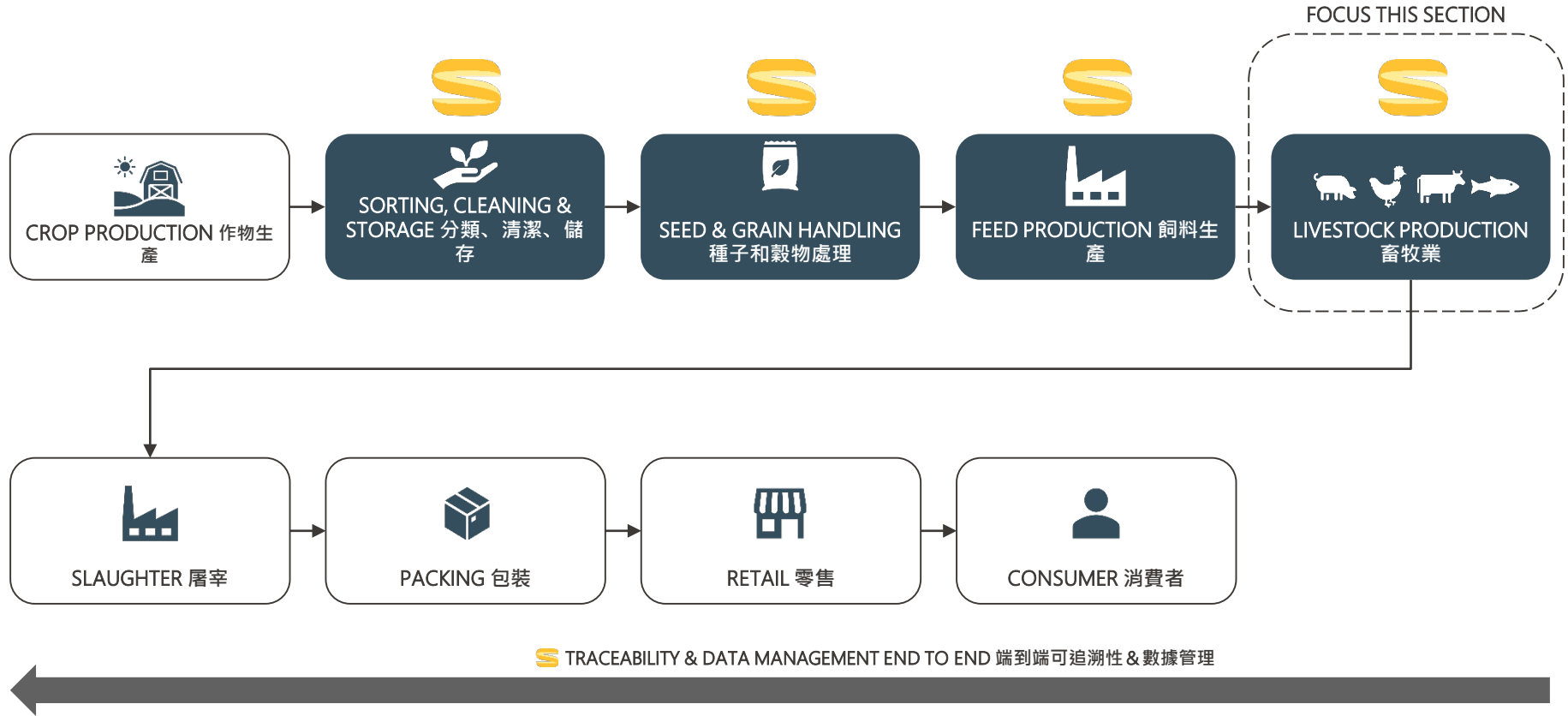



WHY SKIOLD DAIRY? 為何選擇我們？



SKIOLDGROUP

- KNOW-HOW AND EXPERIENCE TO SERVE THE MOST DEMANDING AND BEST PERFORMING PRODUCERS 擁有服務最佳的生產者的知識及經驗
- LOWEST COST / UNIT PRODUCED 最低成本 / 單位生產
- DESIGN FOR THE ANIMALS' NATURAL BEHAVIOUR 依動物的自然行為設計
- ANIMALS' COMFORT IN FOCUS TO INCREASE MILK YIELD 動物的舒適感增加了牛奶的產量
- LESS FEED & WATER CONSUMPTION 較少的水及飼料消耗
- WORKING ENVIRONMENT ATTRACTIVE 工作環境的吸引力



FINANCIAL PERFORMANCE 財務表現



ANIMAL WELFARE 動物福祉



HUMAN WELFARE 人類福祉



SUSTAINABILITY 永續經營

THE OPTIMAL DAIRY CATTLE BARN

最佳乳牛牛舍

By CATHERINE
Perrier-Kongsgaard





SKIOLDGROUP

THE PROPER
CLIMATE FOR
PRODUCTION
適宜的生活環境

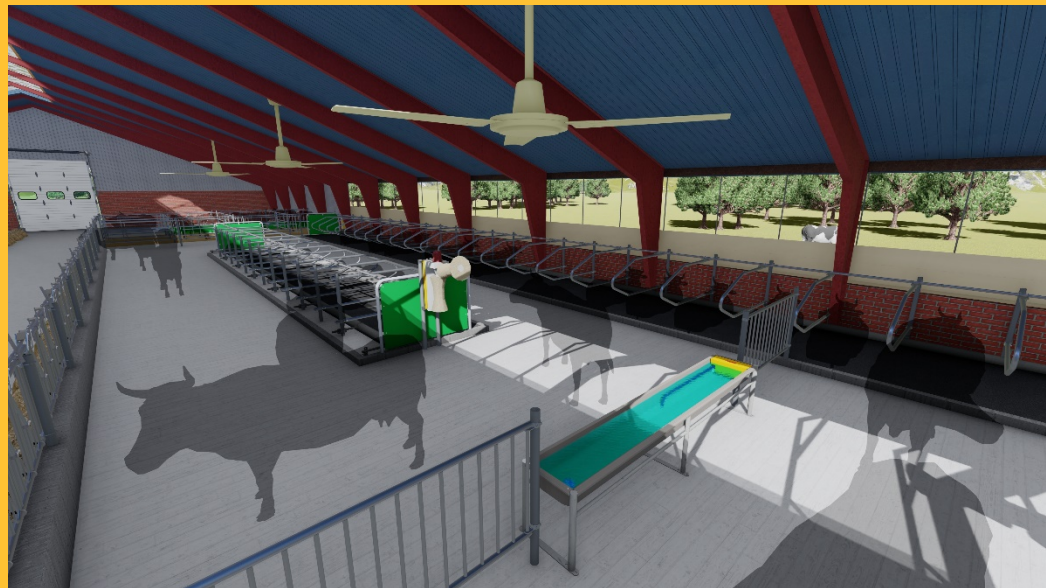

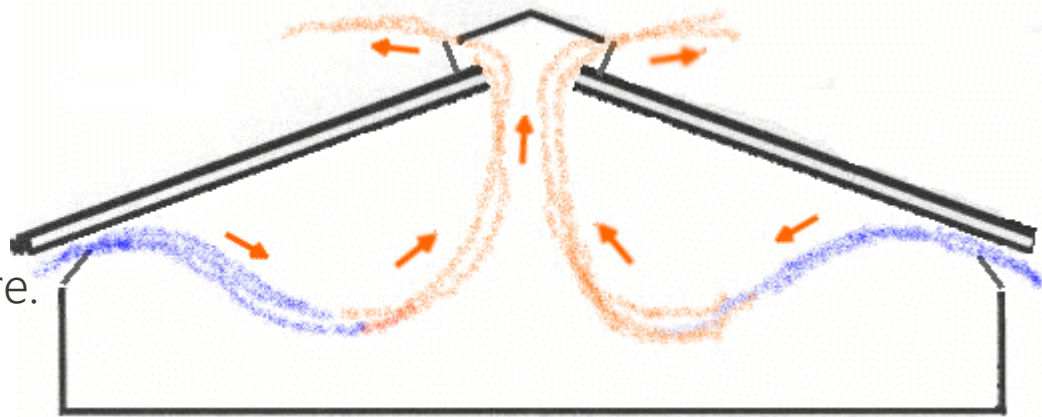
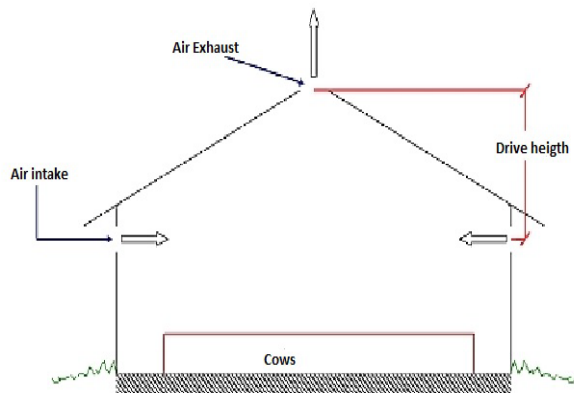

Drive height provides Negative pressure.

驅動器高度可提供負壓

Thermal buoyance from cattle

牛產生的熱浮力

Wind impact on side of building 風對建築物側面的影響



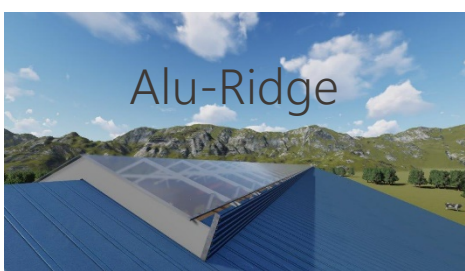

Alu-Ridge



MFS36-52Fans



Dairy C
Dairy M



Folding curtain



Barn
牛舍



Light Panels



Roller curtain



Topfixed roller curtain



風扇 Breeze Fans





SKIOLDGROUP

REDUCE STRESS AT
FEED TABLE
減少飼料台上的壓力



METABOLIC DISORDERS 代謝紊亂

- ACIDOSIS 酸中毒
 - Early lactation disease 早期泌乳疾病
 - Rushed short meals -> high feeding rate
匆忙、吃少量 → 高餵食率
 - Not enough roughage -> sorting
粗料不足 → 分類排序
- KETOSIS 酮症
 - Fresh cow disease 剛產母牛的疾病
 - Energy intake < energy need 能量攝入 < 能量需求

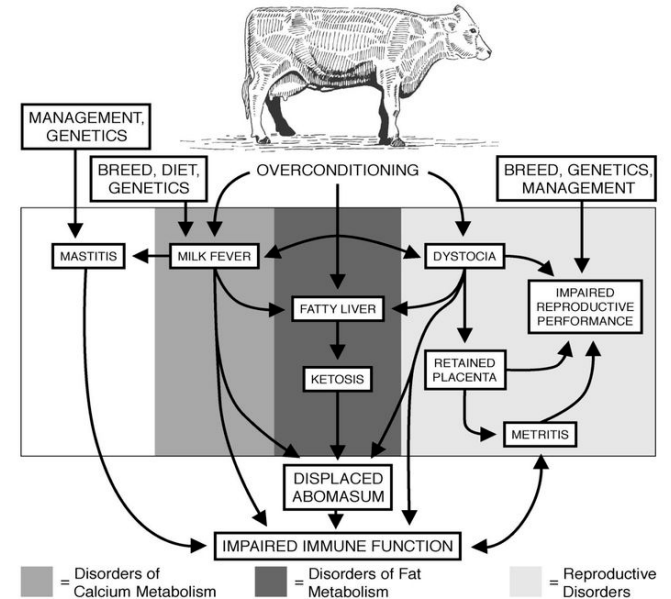



PROS & CONS 優點與缺點 (- 代表缺點，+代表優點)

	Headlock	Neck rail 頸桿
Flexibility 靈活性	— Same height for all 都統一高度 + Adjustable opening 開口能調整	+ Adjustable height according to animal group 能依動物調整高度
Access to feed 餵食的管道	—More restriction 較多限制 + 1 defined spot for each cow 每頭牛有一個位置	—High risk of bullying 高機率的牛隻排擠問題 + Better reach to the feeding table 較容易碰到飼料槽
Animal management 動物管理層面	+ Safe & stressfree handling 安全且無壓力	—Requires a specific treatment area 需要特定區域

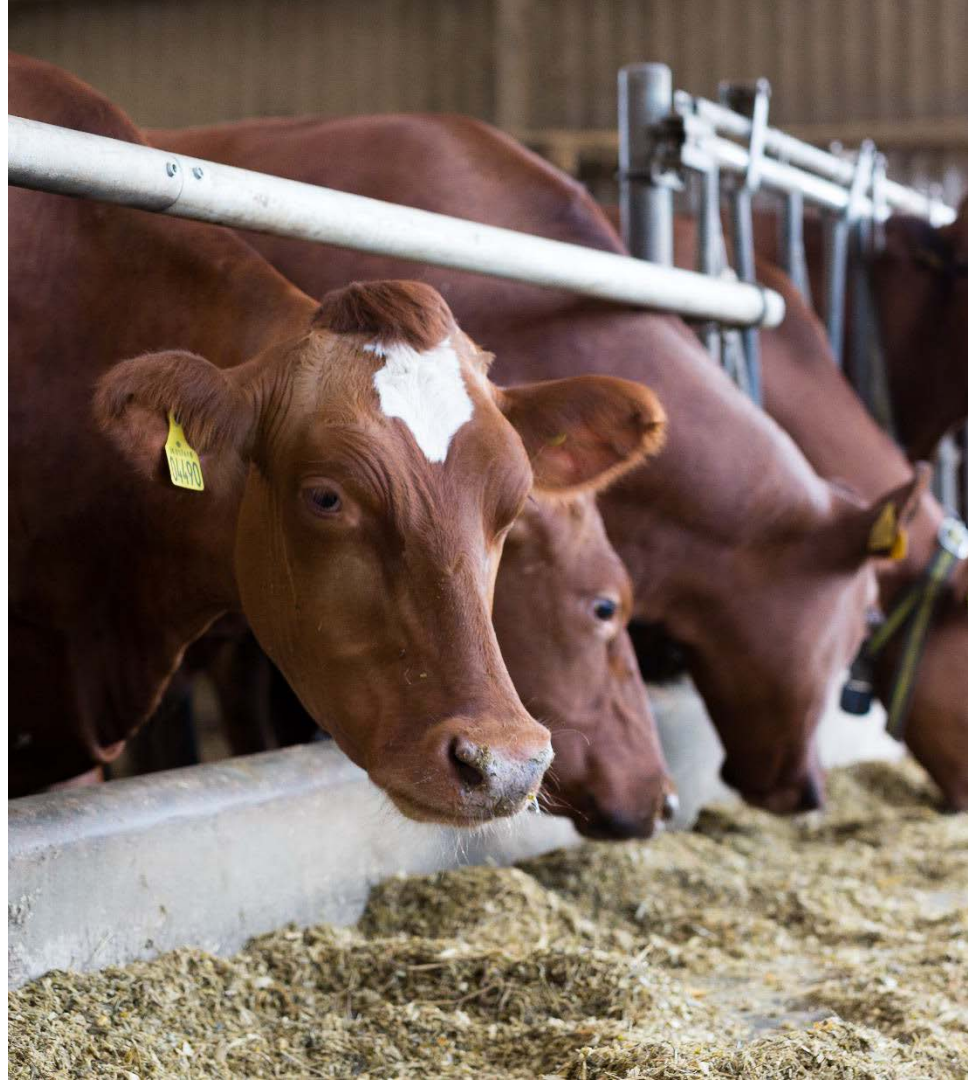



SKIOLDGROUP

DEFINING THE
PROPER RESTING
SPACE 定義適當
的休息空間



DANISH RECOMMENDATIONS 丹麥的建議

- 1,25 m wide for Holstein cows, 1,10 m for Jersey
- 荷蘭牛：1.25公尺；娟姍牛：1.1公尺

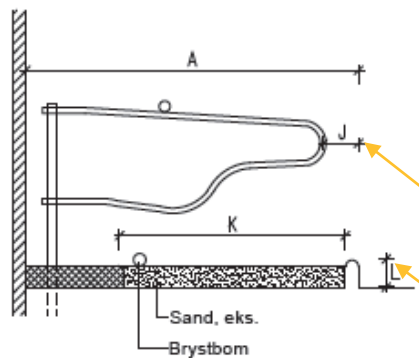
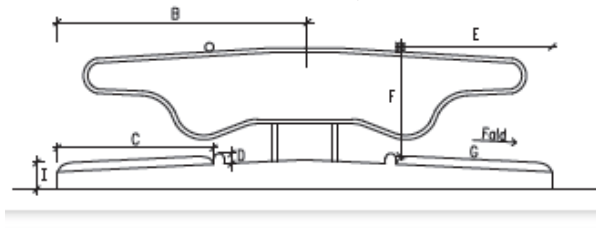

In meters (公尺)	Holstein 荷蘭牛	Jersey 娟姍牛
A	3	2,8
B	2,85	2,65
C	1,80	1,65
E	1,75	1,60
F	1,20	1,05

J: 30 cm

L: 25 cm



SKIOLD STALL SOLUTION 牛欄設備方案

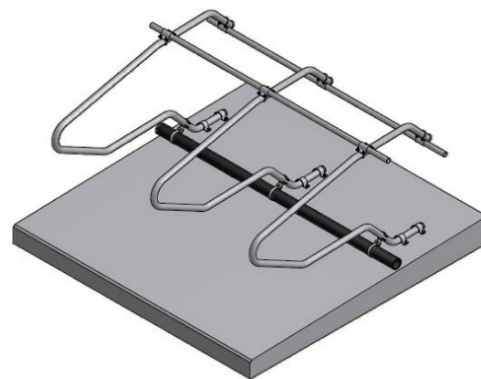

Importance of mattresses 床墊的重要性

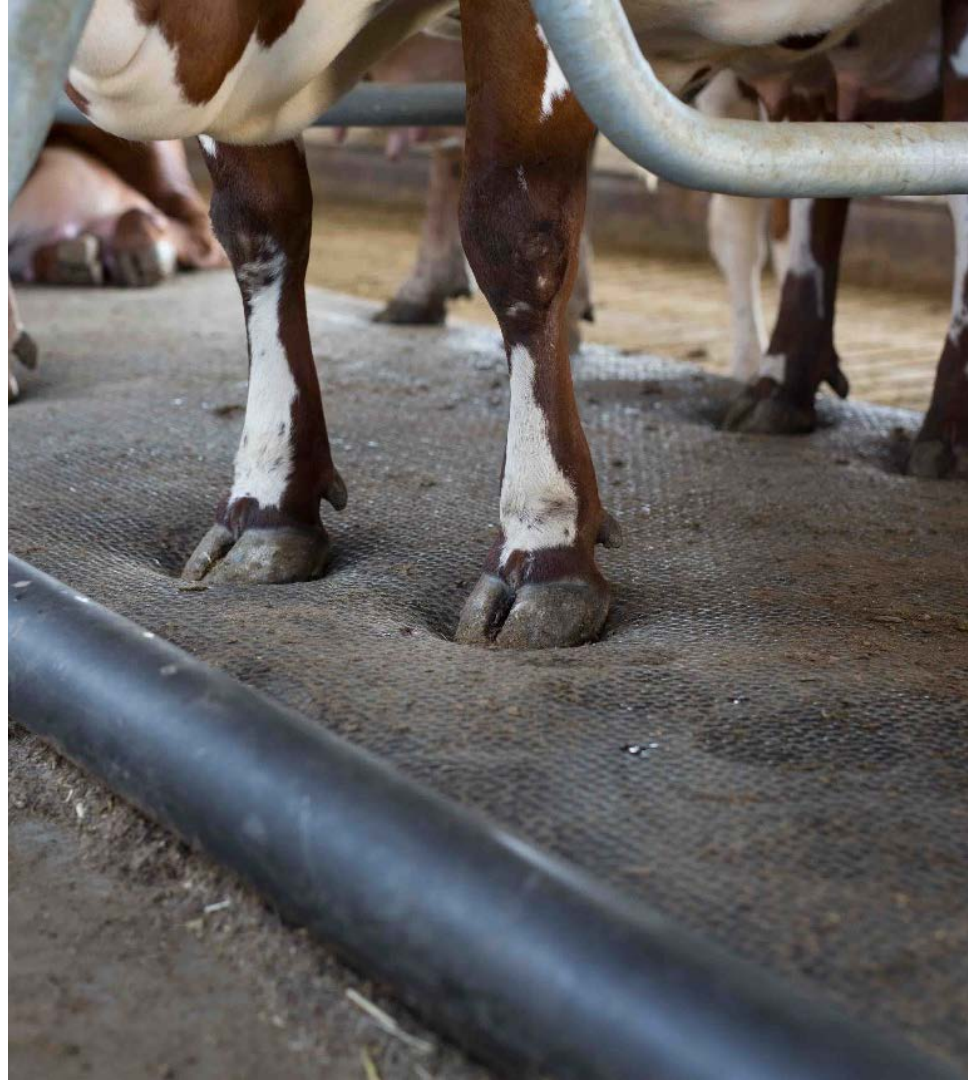

One example 實例 – before 前 / after後



SKIOLD COMPLETE SOLUTION FOR CATTLE BARNES



SKIOLDGROUP

